

F - T H E T A L E N S

f-150-12-10.6

en | Data sheet | 1.1

- F-Theta Lens 10600 nm, ZnSe
- Nominal focal length 150 mm
- Max. input beam diameter 12 mm
- Maximum working area 110 x 110 mm



Wavelength	10600 nm	Minimum spot size	242.48 µm
Nominal focal length	150 mm	Mirror distance m1/m2	12.5 / 20 mm
Effective focal length	149.500 mm	Anti-reflective coating	Standard
Flange focal length	137.500 mm	Cooling method	Air
Max. input beam diameter	12 mm	Lens material	ZnSe
Working distance	131.500 mm	Mounting thread	M85x1
Max. scan field	110 x 110 mm	Lens diameter	90 mm

Information is subject to change without notice. Product photos are non-binding and may show customized features.



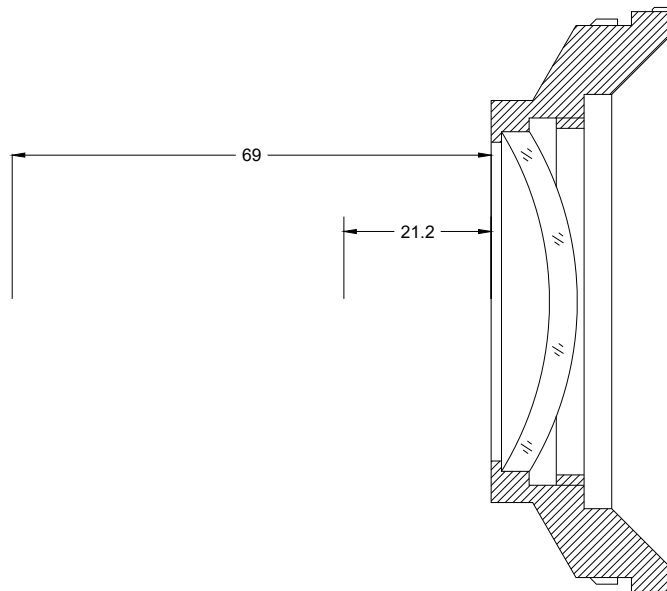
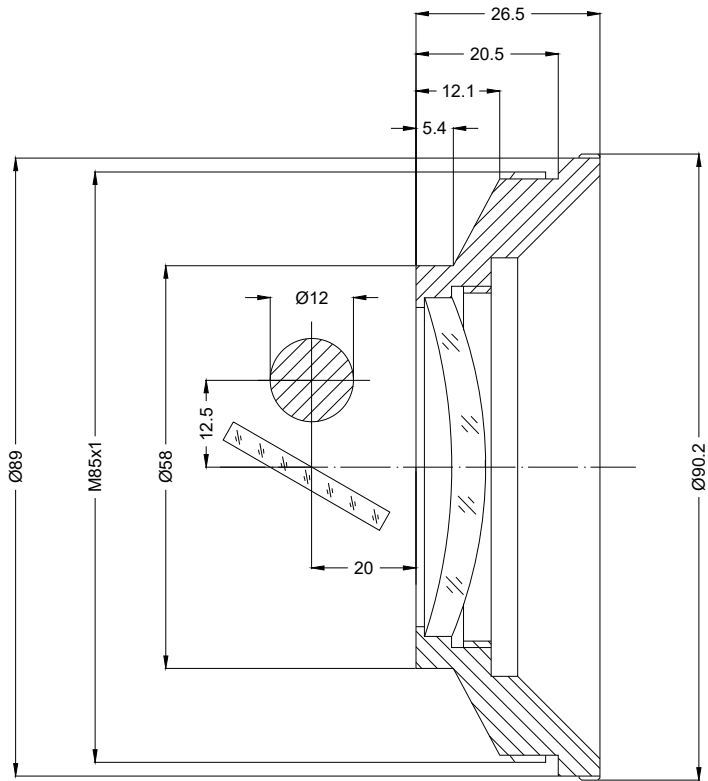

F-Theta lens

f-150-12-10.6

Dimensions are given in millimeters and are intended as reference values.
Binding information is available on request.

