

F - T H E T A L E N S

# f-250-15-10.6

en | Data sheet | 1.1

- F-Theta Lens 10600 nm, ZnSe
- Nominal focal length 250 mm
- Max. input beam diameter 15 mm
- Maximum working area 175 x 175 mm



Wavelength	10600 nm	Minimum spot size	323.3 μm
Nominal focal length	250 mm	Mirror distance m1/m2	17.4 / 17 mm
Effective focal length	246.684 mm	Anti-reflective coating	Standard
Flange focal length	234.068 mm	Cooling method	Air
Max. input beam diameter	15 mm	Lens material	ZnSe
Working distance	244.600 mm	Mounting thread	M85x1
Max. scan field	175 x 175 mm	Lens diameter	90 mm

Information is subject to change without notice.  
Product photos are non-binding and may show customized features.



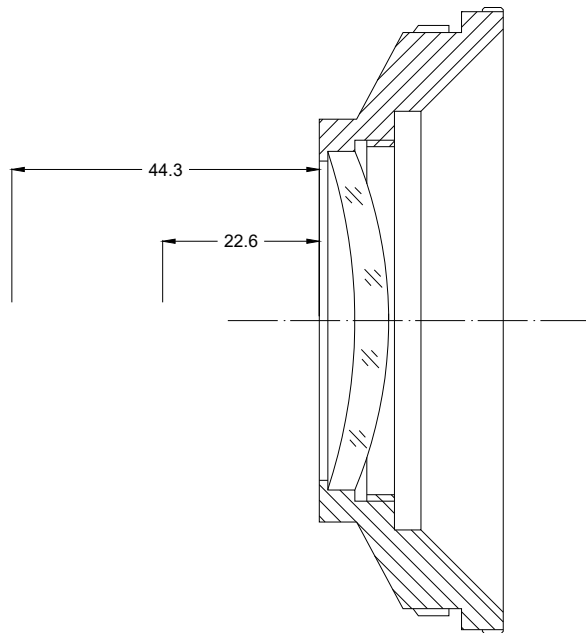
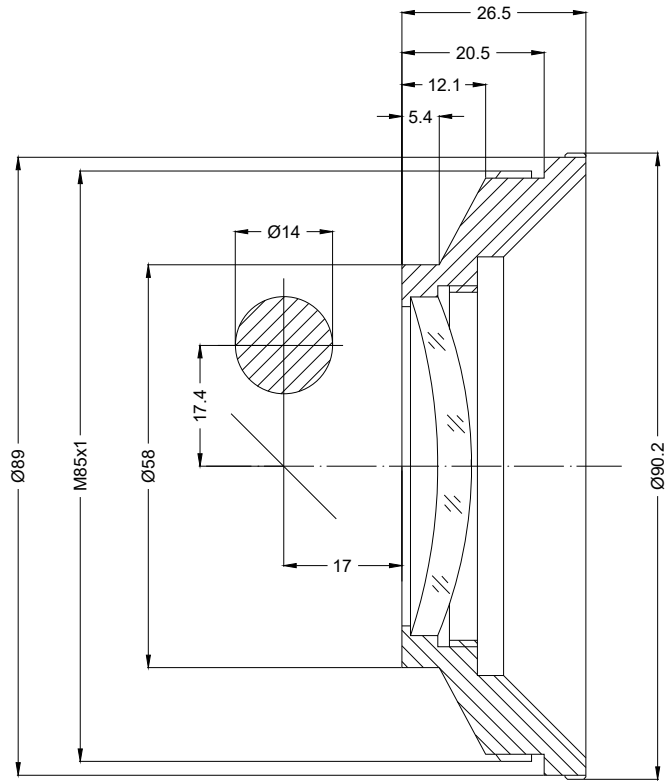

F-Theta lens

f-250-15-10.6

Dimensions are given in millimeters and are intended as reference values.  
Binding information is available on request.

