

F - T H E T A L E N S

f-930-14-10.6

en | Data sheet | 1.1

- F-Theta Lens 10600 nm, ZnSe
- Nominal focal length 930 mm
- Max. input beam diameter 14 mm
- Maximum working area 700 x 700 mm



Wavelength	10600 nm	Minimum spot size	1130 μ m
Nominal focal length	930 mm	Mirror distance m1/m2	17 / 17.4 mm
Effective focal length	930.000 mm	Anti-reflective coating	Standard
Flange focal length	925.750 mm	Cooling method	Air
Max. input beam diameter	14 mm	Lens material	ZnSe
Working distance	919.750 mm	Mounting thread	M85x1
Max. scan field	700 x 700 mm	Lens diameter	90 mm

Information is subject to change without notice.
Product photos are non-binding and may show customized features.



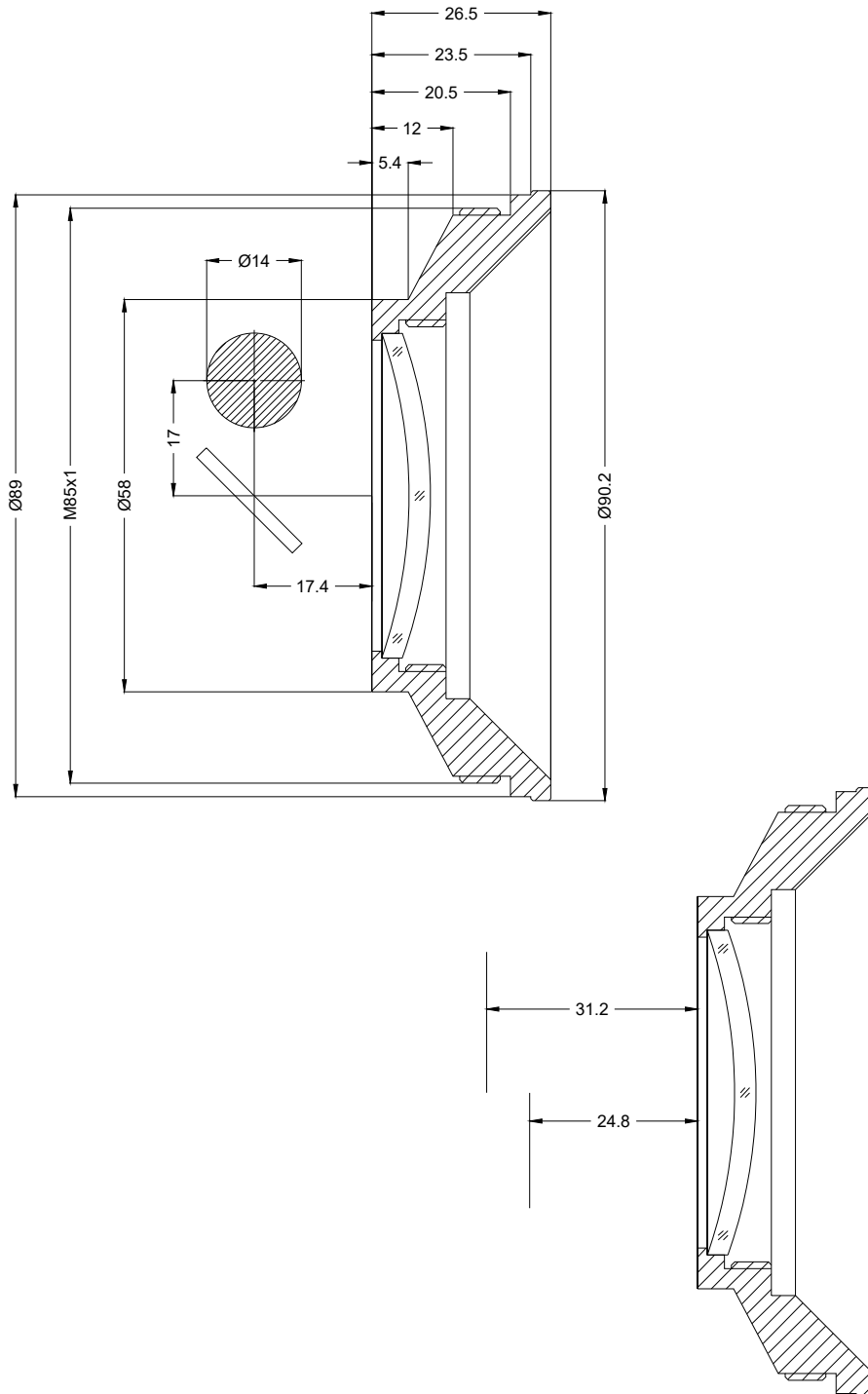

F-Theta lens

f-930-14-10.6

Dimensions are given in millimeters and are intended as reference values.
Binding information is available on request.

