

F - T H E T A L E N S

f-254-10-1064

en | Data sheet | 1.1

- F-Theta Focusing Lens, 1064 nm
- Nominal focal length 254 mm
- Max. input beam diameter 10 mm
- Maximum working area 175 x 175 mm



Wavelength	1064 nm	Minimum spot size	49.46 μ m
Nominal focal length	254 mm	Mirror distance m1/m2	12.5 / 15 mm
Effective focal length	253.217 mm	Anti-reflective coating	Standard
Flange focal length	286.202 mm	Cooling method	Air
Max. input beam diameter	10 mm	Lens material	Optical glass
Working distance	277.702 mm	Mounting thread	M85x1
Max. scan field	175 x 175 mm	Lens diameter	90 mm

Information is subject to change without notice.
Product photos are non-binding and may show customized features.



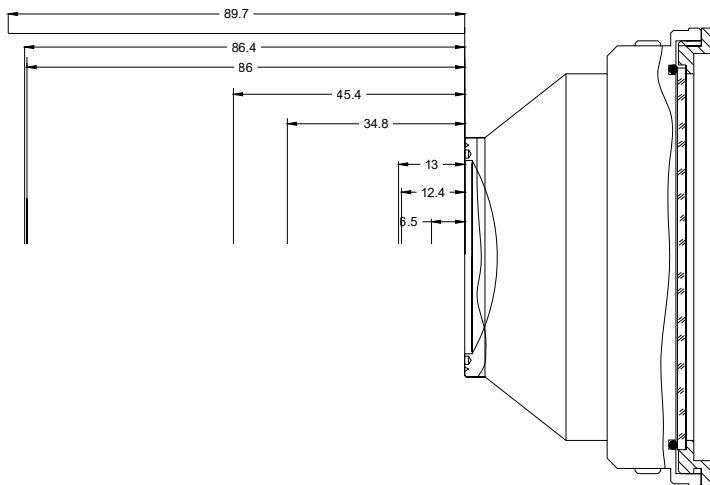
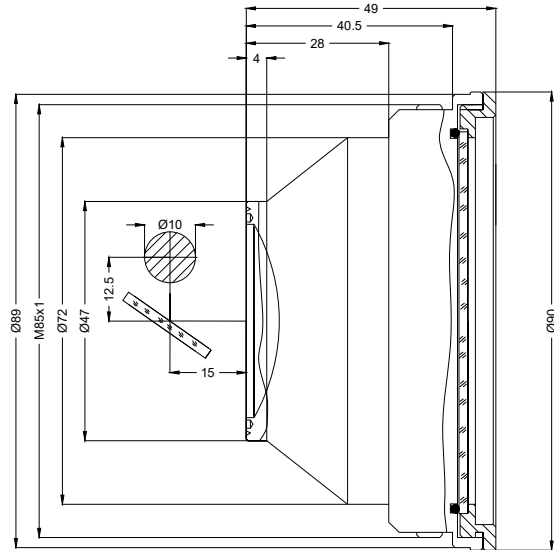

F-Theta lens

f-254-10-1064

Dimensions are given in millimeters and are intended as reference values.
Binding information is available on request.

