

F - T H E T A L E N S

f-254-30-1064-M112

en | Data sheet | 1.1

- F-Theta Focusing Lens, 1064 nm
- Nominal focal length 254 mm
- Max. input beam diameter 30 mm
- Maximum working area 150 x 150 mm
- Very fine focus, high precision



Wavelength	1064 nm	Minimum spot size	16.49 μ m
Nominal focal length	254 mm	Mirror distance m1/m2	37.12 / 20 mm
Effective focal length	253.261 mm	Anti-reflective coating	Standard
Flange focal length	356.577 mm	Cooling method	Air
Max. input beam diameter	30 mm	Lens material	Optical glass
Working distance	292.077 mm	Mounting thread	M112x1
Max. scan field	150 x 150 mm	Lens diameter	140 mm

Information is subject to change without notice.
Product photos are non-binding and may show customized features.



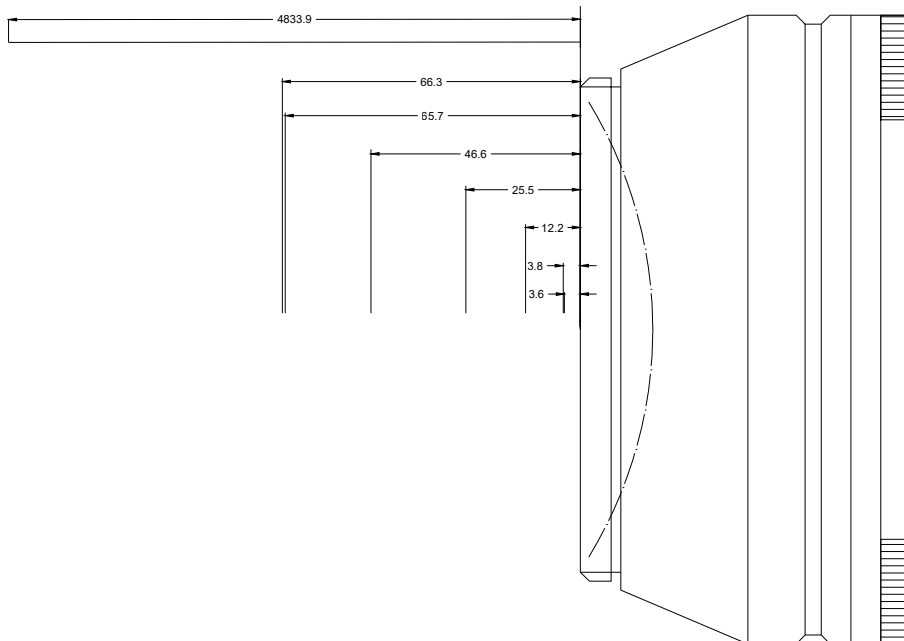
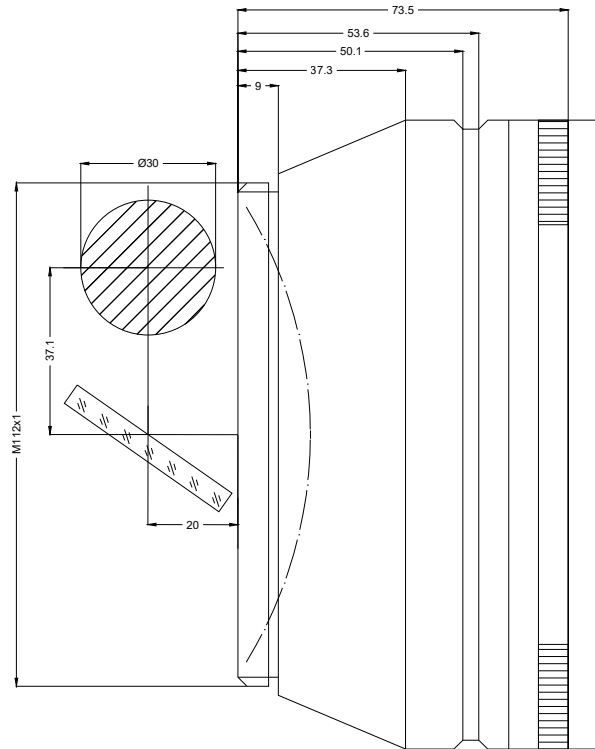

F-Theta lens

f-254-30-1064-M112

Dimensions are given in millimeters and are intended as reference values.
Binding information is available on request.

