

F - T H E T A L E N S

f-525-20-1064

en | Data sheet | 1.1

- F-Theta Focusing Lens, 1064 nm
- Nominal focal length 525 mm
- Max. input beam diameter 20 mm
- Maximum working area 402 x 402 mm



Wavelength	1064 nm	Minimum spot size	51.1 μm
Nominal focal length	525 mm	Mirror distance m1/m2	25.6 / 16 mm
Effective focal length	525.071 mm	Anti-reflective coating	Standard
Flange focal length	649.228 mm	Cooling method	Air
Max. input beam diameter	20 mm	Lens material	Optical glass
Working distance	604.728 mm	Mounting thread	M85x1
Max. scan field	402 x 402 mm	Lens diameter	125 mm

Information is subject to change without notice.
Product photos are non-binding and may show customized features.



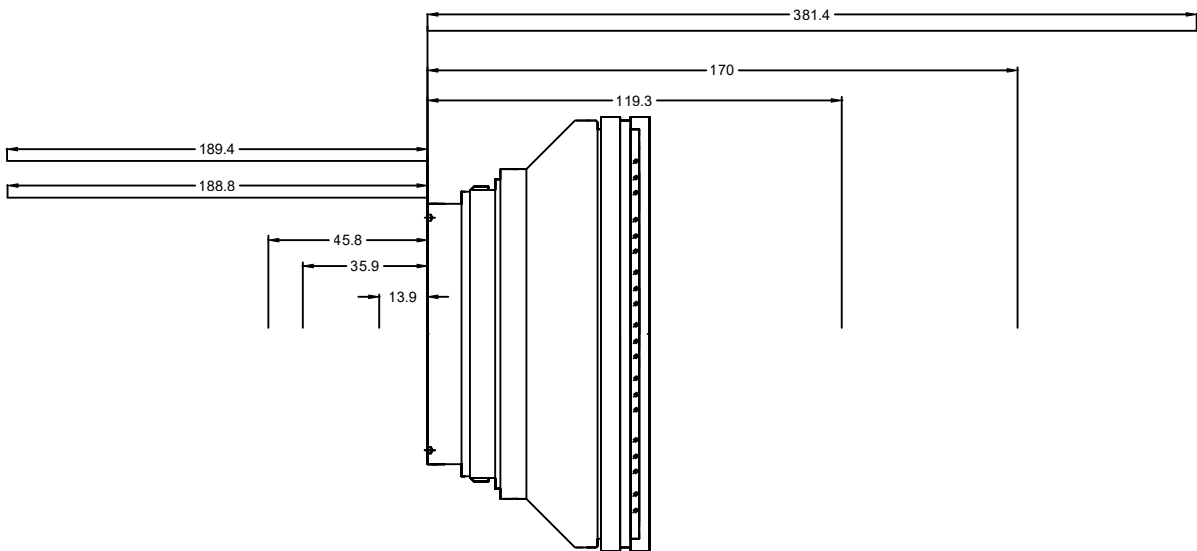
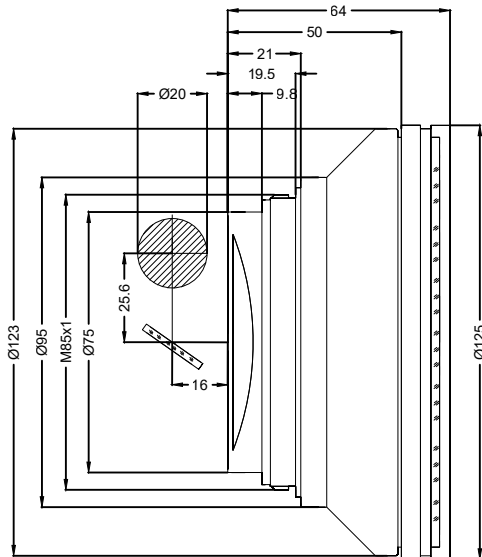

F-Theta lens

f-525-20-1064

Dimensions are given in millimeters and are intended as reference values.
Binding information is available on request.

