

F - T H E T A L E N S

f-160-10-532

en | Data sheet | 1.1

- F-Theta Focusing Lens, 532 nm
- Nominal focal length 160 mm
- Max. input beam diameter 10 mm
- Maximum working area 110 x 110 mm



Wavelength	532 nm	Minimum spot size	15.58 μ m
Nominal focal length	160 mm	Mirror distance m1/m2	12.5 / 15 mm
Effective focal length	160.829 mm	Anti-reflective coating	Standard
Flange focal length	192.675 mm	Cooling method	Air
Max. input beam diameter	10 mm	Lens material	Optical glass
Working distance	189.890 mm	Mounting thread	M85x1
Max. scan field	110 x 110 mm	Lens diameter	120 mm

Information is subject to change without notice.
Product photos are non-binding and may show customized features.



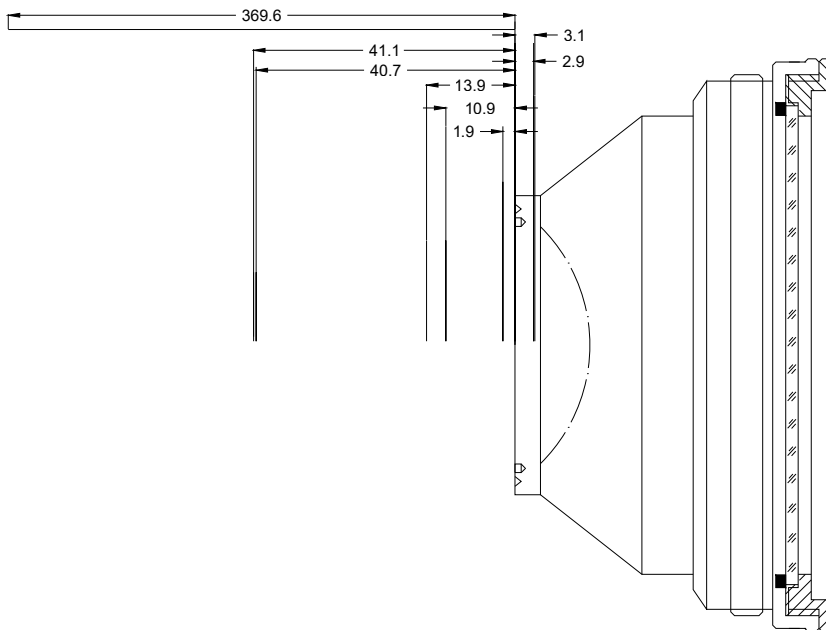
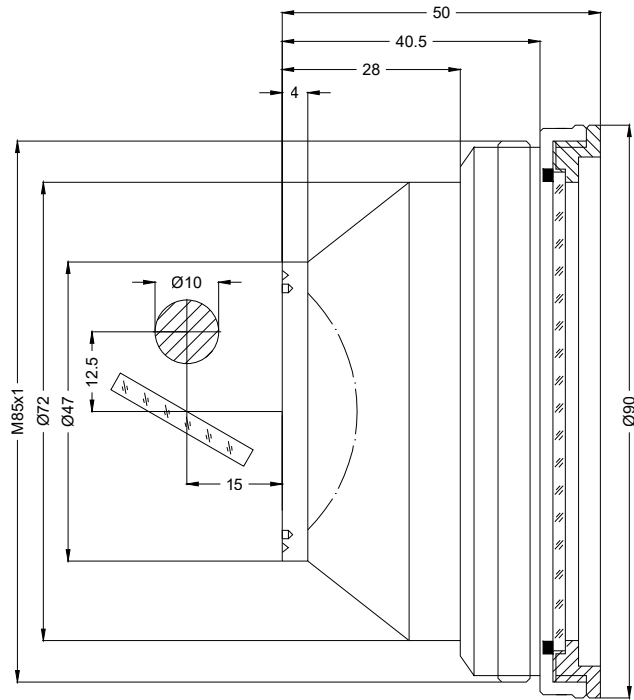

F-Theta lens

f-160-10-532

Dimensions are given in millimeters and are intended as reference values.
Binding information is available on request.

