

F - T H E T A L E N S

f-535-20-532

en | Data sheet | 1.1

- F-Theta Focusing Lens, 532 nm
- Nominal focal length 535 mm
- Max. input beam diameter 20 mm
- Maximum working area 370 x 370 mm



Wavelength	532 nm	Minimum spot size	26.04 µm
Nominal focal length	535 mm	Mirror distance m1/m2	28.5 / 23 mm
Effective focal length	535.863 mm	Anti-reflective coating	Standard
Flange focal length	668.674 mm	Cooling method	Air
Max. input beam diameter	20 mm	Lens material	Optical glass
Working distance	623.674 mm	Mounting thread	M85x1
Max. scan field	370 x 370 mm	Lens diameter	125 mm

Information is subject to change without notice.
Product photos are non-binding and may show customized features.



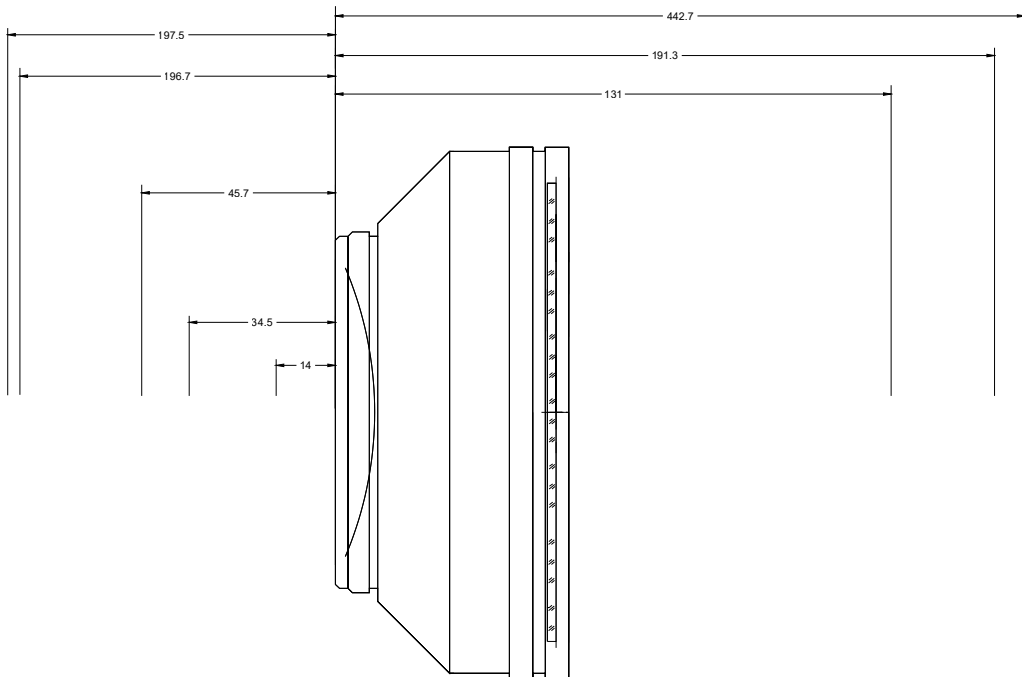
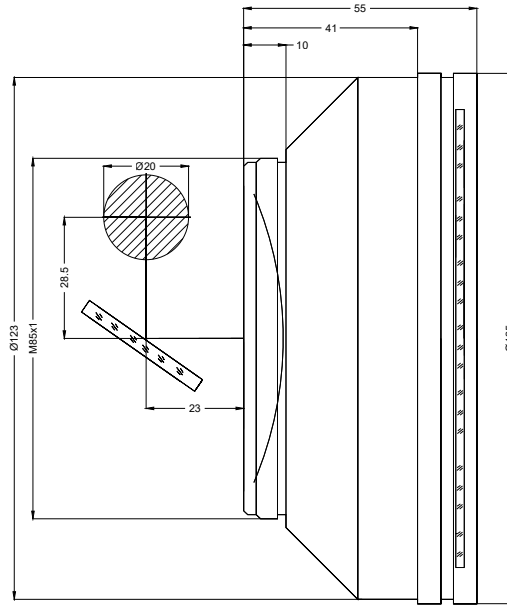

F-Theta lens

f-535-20-532

Dimensions are given in millimeters and are intended as reference values.
Binding information is available on request.

