

F - T H E T A L E N S

f-300-14-9.3

en | Data sheet | 1.1

- F-Theta Lens 9300 nm, ZnSe
- Nominal focal length 300 mm
- Max. input beam diameter 14 mm
- Maximum working area 210 x 210 mm



Wavelength	9300 nm	Minimum spot size	425.48 µm
Nominal focal length	300 mm	Mirror distance m1/m2	17.4 / 17 mm
Effective focal length	300.000 mm	Anti-reflective coating	Standard
Flange focal length	298.221 mm	Cooling method	Air
Max. input beam diameter	14 mm	Lens material	ZnSe
Working distance	295.966 mm	Mounting thread	M85x1
Max. scan field	210 x 210 mm	Lens diameter	90 mm

Information is subject to change without notice.
Product photos are non-binding and may show customized features.



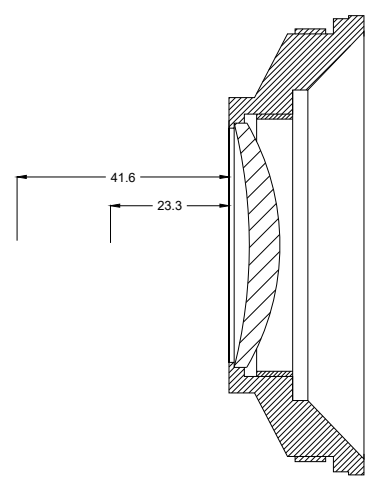
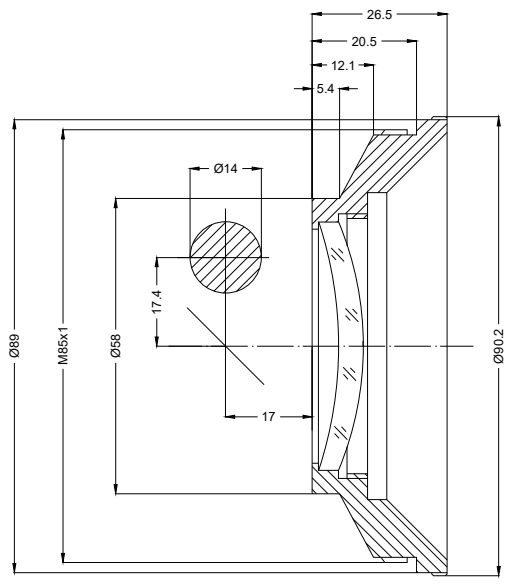

F-Theta lens

f-300-14-9.3

Dimensions are given in millimeters and are intended as reference values.
Binding information is available on request.

